

Order Form/Design Configuration for the Positioning Systems Frame “Adacta Klim”

Order Quotation

<u>Invoicing Details</u>	<u>Shipping Details</u>
Company name: _____ Delivery date required: ___/___/___ Delivery address: _____ P. Code.: _____ Town: _____ Tel.: _____ Fax: _____ # Order: _____ Date of the Order: ___/___/___	Ship to: _____ _____ <p style="text-align: center;">CUSTOMER STAMP AND SIGNATURE</p>

Pro Medicare srl grants **24 months** warranty on production defects from the date of the first put into service and **12 months** on covers and components subjected to wearing. Warranty is void if the product is used in any other way than stated in the Instruction Manual.

Note: Any request for variation in dimensions, materials and type compared to the standard does not have CE marking, therefore the professional user becomes the manufacturer and has the obligation to draw up the technical documentation of the device (this is valid for the sections of the sheet with the letter W).

Images are purely illustrative and may not fully reflect reality.

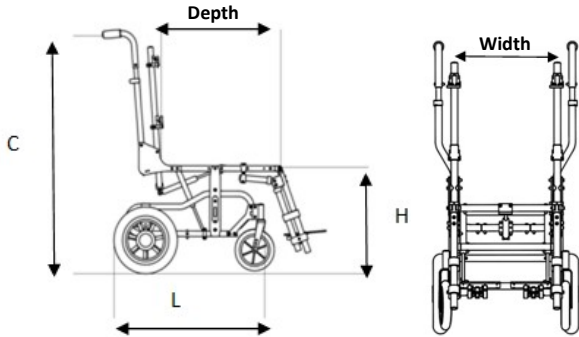
Fundamental parts	
<ul style="list-style-type: none"> - Rigid frame subjected to oxidation process color titanium - Folding down backposts, shock-absorbing with gas springs and folding down telescopic and turning push handles angle adjustable (max height adjustment 15 cm) - Continuous tilt in space with gas spring* from 0° up to 25°; - Backrest angle starting recline adjustable from 0° to 20°, elastic recline up to 20° - Knee angle adjustable up to 15°, and another 20° thanks to the shock-absorbing/elastic extension - Continuous displacement of the upper frame with respect to under frame - Continuous displacement of the rear wheels plates - Fixed anti-tip system - Wheels Kit with brake - Knee angle elevation continuously adjustable - Downward shock-absorbing footplates hangers - Footrest - Footrest height adjustable <p>* guaranteed by operating first on the reclining and then on the tilt in space</p>	

Frame Color: Titanium

Frame size

(Width measurements are from tube to tube externally, while depth measurements are from back post to footboard engagement)

Choice of the Height

		Seat Width (cm)	Depth and Adjustments (cm)	Size	Height (cm)	
Paediatric	<input type="checkbox"/> XXS	35	38	XXS	<input type="checkbox"/> 43 <input type="checkbox"/> 46 <input type="checkbox"/> 49	H: height (distance from the seat rails to pavement detected from its middle point); C: distance of the pushing handles to pavement: 110cm; Note: the height will be confirmed by Technical Sales Department
	<input type="checkbox"/> XS	35	42	XS		
Adult	<input type="checkbox"/> XS1	38	46	XS1		
	<input type="checkbox"/> S	41	46	S		
	<input type="checkbox"/> M	41	50	M-M1		
	<input type="checkbox"/> M1	44	50	<input checked="" type="checkbox"/> = Standard; <input type="checkbox"/> = Optional		

FRAME OPTIONS

*Note: If no option is selected, the option written in **bold** will be considered for the frame*

Castors

150mm (6") poly grey *black* 175mm (7") poly *grey* *black*

Posterior Wheels

- 300mm (12") poly grey** with parking brake lever
- 300mm (12") poly *black* with parking brake lever
- 300mm (12") pneumatic *grey* with parking brake lever
- 300mm (12") poly *black* with drum brake
- 300mm (12") poly *grey* with drum brake
- 300mm (12") pneumatic *grey* with drum brake
- 300mm (12") poly *black* with drum brake and parking brake lever
- 300mm (12") poly *grey* with drum brake and parking brake lever
- 300mm (12") pneumatic *grey* with drum brake and parking brake lever
- 400mm (16") poly *black* with parking brake lever (*only 45 cm height*)
- 400mm (16") poly *black* with drum brake (*only 45 cm height*)
- 400mm (16") poly *black* with drum brake and parking brake lever (*only 45 cm height*)
- 500mm (20") poly *grey* with handrims with parking brake lever
- 500mm (20") pneumatic *grey* with handrims with parking brake lever
- 500mm (20") pneumatic *grey* with handrims with drum brake
- 500mm (20") pneumatic *grey* with handrims with drum brake and parking brake lever

Footrest

- footplates** footboard
- Flex-extension shock-absorbing mechanism (*for footplates only*) RH LH
- Positioning ankle support RH LH
- Padding and cover *in leather flex* divided one piece

Tilt in space

- ◇ **with lever** *with pedal*

Anti-tip system

- ◇ **fixed** *detachable*

Pedal for barriers

side RH LH

Back's gas spring

- ◇ **150N** (*from size XXS to XS1*) and **200N** (*from size S to M1*) Specify if you will install a spring intensity other than the standard one
 150N **200N**

FRAME ACCESSORIES

Seat Base **Note:** The wooden seat bases present posterior notches of 6 cm for easy movement on the seat rails

- wooden seat base covered with black leather flex (*with male Velcro and additional female kit*)
- wooden seat base with mounting kit
- fixed grey wooden seat base with slots

Backrest base

- wooden backrest base covered with black leather flex (*with male Velcro and additional female kit*)
- wooden backrest base with mounting kit

Leg support

Separate Leg Cradle (*adjustable in height and depth*) RH LH custom **W**

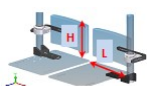

cm	XXS	XS	XS1	S	M	M1	W
H	12.5	12.5	15	15	18	18
L	12.5	12.5	12.5	14	14	15.5

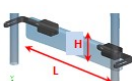

Calf panel (*adjustable in height and depth*) custom **W**

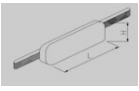

cm	XXS	XS	XS1	S	M	M1	W
H	12	12	15	18	18	18
L	26.5	26.5	25	28	28	31

<input type="checkbox"/> Padded calf strap								<input type="checkbox"/> custom W
	cm	XXS	XS	XS1	S	M	M1	W
	H	11	11	11	13	13	13
	L	31	31	34	37	37	40
<input type="checkbox"/> Simple calf strap <i>Height 4cm</i>								<input type="checkbox"/> custom W
Cover for legrest tube <input type="checkbox"/> RH <input type="checkbox"/> LH								

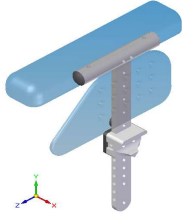
Armrest



<input type="checkbox"/> Kit of ABS laterals multi-adjustable, detachable and with multi-adjustable arm support <i>in width and depth with a gap of 2.5 cm</i> <u>make a selection:</u> <input type="radio"/> small arm support (from US to XS0) (dimensions: 5 cm x 25 cm) <input type="radio"/> large arm support (from XS1 to XL) (dimensions: 6 cm x 30 cm)	
<input type="checkbox"/> Kit of hardware multi-adjustable, detachable for ABS laterals <u>make a selection:</u> <input type="radio"/> short vertical bar (from 19 cm to 28 cm*) <input type="radio"/> long vertical bar (from 26 cm to 35 cm*) *distance from hardware to the seat rail <u>make a selection:</u> <input type="radio"/> hip guide pad ① see below <input type="radio"/> arm support pad ② see below ABS Lateral: <input type="checkbox"/> RH <input type="checkbox"/> LH	
Padding for ABS Laterals <input type="checkbox"/> RH <input type="checkbox"/> LH	
Spacer for ABS laterals <input type="checkbox"/> 1 cm <input type="checkbox"/> 1.5 cm <input type="checkbox"/> 2 cm <input type="checkbox"/> RH <input type="checkbox"/> LH	

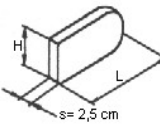
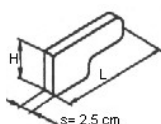

Hip Guides

<input type="checkbox"/> Linear Hip Guide ① (pad only)								<input type="checkbox"/> Contoured Hip Guide ① (pad only)							
<input type="checkbox"/> Linear Hip Guide pad w/mounting bracket								<input type="checkbox"/> Contoured Hip Guide pad w/mounting bracket							
	cm	XS	S	M	L	W_{RH}	W_{LH}		cm	XS	S	M	L	W_{RH}	W_{LH}
	H	8	10	10	12		H	8	10	10	12
	L	22	25	30	35		L	22	25	30	35
Side	Pad size	Select the bracket*				Select the bracket shape*		Side	Pad size	Select the bracket*				Select the bracket shape*	
<input type="checkbox"/> RH		<input type="checkbox"/> Fixed <input type="checkbox"/> Detachable				<input type="checkbox"/> A <input type="checkbox"/> B <input type="checkbox"/> C <input type="checkbox"/> D		<input type="checkbox"/> RH		<input type="checkbox"/> Fixed <input type="checkbox"/> Detachable				<input type="checkbox"/> A <input type="checkbox"/> B <input type="checkbox"/> C <input type="checkbox"/> D	
<input type="checkbox"/> LH		<input type="checkbox"/> Fixed <input type="checkbox"/> Detachable				<input type="checkbox"/> A <input type="checkbox"/> B <input type="checkbox"/> C <input type="checkbox"/> D		<input type="checkbox"/> LH		<input type="checkbox"/> Fixed <input type="checkbox"/> Detachable				<input type="checkbox"/> A <input type="checkbox"/> B <input type="checkbox"/> C <input type="checkbox"/> D	
Bracket Padding: <input type="checkbox"/> RH <input type="checkbox"/> LH								Bracket Padding: <input type="checkbox"/> RH <input type="checkbox"/> LH							

Note: If the bracket feature is not selected the fixed bracket will be delivered; for the choice of bracket shape see below

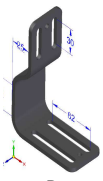
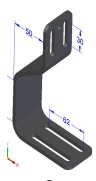
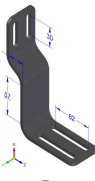
***Brackets** (They allow adjustments of the seat and/or backrest width)

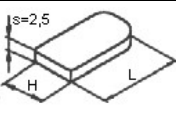
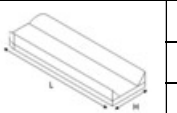
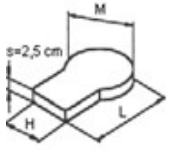

Shape A L/90° Bracket allows a reduction of the width up to 2.5 cm per side B 2.5 cm Offset Bracket allows a reduction of the width up to 5 cm per side C 5 cm Offset Brackets allows a reduction of the width up to 7.5 cm per side D Reverse Bracket doesn't allow any variation of the width	Type  Fixed Bracket  Detachable Bracket
 A  B  C  D	

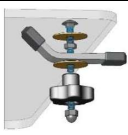
Arm Supports															
<input type="checkbox"/> Flat Arm Support ② (pad only)							<input type="checkbox"/> Inside/outside flat Contoured Arm Support ② (pad only)								
<input type="checkbox"/> Flat arm support w/brackets							<input type="checkbox"/> Inside/outside flat Contoured arm support w/brackets								
															
cm		XS	S	M	L	W _{RH}	W _{LH}	cm		XS	S	M	L	W _{RH}	W _{LH}
H		8	10	10	12	H		8	10	10	12
L		22	25	30	35	L		22	25	30	35
Side		Size					Side		Size						
<input type="checkbox"/> RH							<input type="checkbox"/> RH								
<input type="checkbox"/> LH							<input type="checkbox"/> LH								
<input type="checkbox"/> Flat and Shaped Arm Support ② (pad only)							<input type="checkbox"/> Inside/outside Contoured and Shaped Arm Supports ② (pad only)								
<input type="checkbox"/> Flat and Shaped Arm Support w/brackets							<input type="checkbox"/> Inside/outside Contoured and Shaped Arm Supports w/brackets								
															
cm		XS	S	M	L	W _{RH}	W _{LH}	cm		XS	S	M	L	W _{RH}	W _{LH}
H		8	10	10	12	H		8	10	10	12
L		30	35	40	48	L		30	35	40	48
M		12	15	17	17	M		12	15	17	17
Side		Type of Shape			Size		Side		Type of Shape			Size			
<input type="checkbox"/> RH		<input type="radio"/> palmar <input type="radio"/> elbow					<input type="checkbox"/> RH		<input type="radio"/> palmar <input type="radio"/> elbow						
<input type="checkbox"/> LH		<input type="radio"/> palmar <input type="radio"/> elbow					<input type="checkbox"/> LH		<input type="radio"/> palmar <input type="radio"/> elbow						

Wooden Tray					
<input type="checkbox"/> Ergonomic		<input type="checkbox"/> w/lateral flip <input type="checkbox"/> detachable		Type of hardware	
<input type="checkbox"/> Rectangular		<input type="checkbox"/> w/lateral flip <input type="checkbox"/> detachable		 lateral flip	
				 detachable	

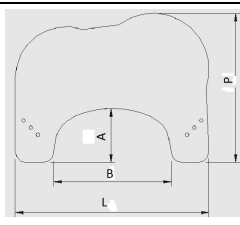
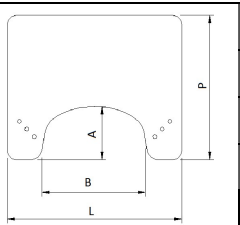
Padding <input type="checkbox"/> black leather flex <input type="checkbox"/> blue leather flex	
<input type="checkbox"/> Outer Edge	

ergonomic tray dimensions						rectangular tray dimensions					
											
Size cm	<input type="checkbox"/> US	<input type="checkbox"/> P	<input type="checkbox"/> M	<input type="checkbox"/> G		Size cm	<input type="checkbox"/> US	<input type="checkbox"/> P	<input type="checkbox"/> M	<input type="checkbox"/> G	
P	47	53	58	66		P	45	50	55	63	
L	58	69	75	86		L	56	66	71	82	
B	35	42	49	55		B	35	42	48	55	
A	17	19	21	24		A	17	19	21	24	

Pelvic Belt (Versa Fixatis Range)							
		<input type="checkbox"/> XS	<input type="checkbox"/> S	<input type="checkbox"/> M	<input type="checkbox"/> L		
		H (pad height) (cm)		4.5	5.5	7	7
Pelvic belt with 2 fixing points and 2 adjustments with plastic side squeeze buckle		L (pad length) (cm)		12	17	22	27
		<input type="checkbox"/> S	<input type="checkbox"/> M	<input type="checkbox"/> L			
		H (pad height) (cm)		5.5	7	7	
Pelvic belt with 2 fixing points and 2 adjustments with metal push button buckle		L (pad length) (cm)		17	22	27	

