

Anatomicità e Confort  
sistemi di supporto per il capo

Cuscinetti



Cuscinetto PICCOLO  
PMDC04P



Cuscinetto MEDIO  
PMDC04M



Cuscinetto GRANDE  
PMDC04G



Imbottitura antidecubito



Rivestimento sfoderabile lycra/neoprene perforato



Areato



Ignifugo secondo la norma ISO 8191-1



Multiregolabile a regolazione orbitale

Hardware



Staffa orizzontale LUNGA  
PMDC02



Staffa orizzontale CORTA  
PMDC02C



Staffa verticale  
PMDC01

Esempi di montaggio



Configurazioni

Cod. ISO 18.09.39.027

Capitis confort  
compreso di  
hardware con  
staffa orizzontale  
lunga ed attacco  
estraibile

CODICE	MISURA
PMDC01P	Piccolo
PMDC01M	Medio
PMDC01G	Grande

Cod. ISO 18.09.39.027

Capitis confort  
compreso di  
hardware con  
staffa orizzontale  
corta ed attacco  
estraibile

CODICE	MISURA
PMDC01PC	Piccolo
PMDC01MC	Medio
PMDC01GC	Grande

Dettagli tecnici

DIMENSIONI CAPITIS CONFORT  
esprese in centimetri

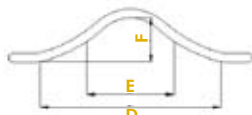
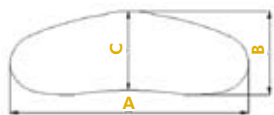

CODICE	A	B	C	D	E	F
PMDC04P	21	14	13	15	08	04
PMDC04M	30	14	13	24	10	05
PMDC04G	42	16	14	34	14	07

DIMENSIONI CAPITIS ANATOMICO  
esprese in centimetri

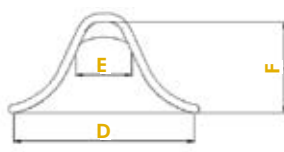
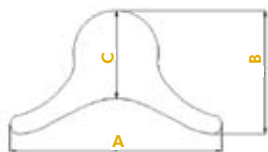

CODICE	A	B	C	D	E	F
PMDC03XP	18	13	08	13	04	02
PMDC03P	24	17	12	19	06	04
PMDC03M	28	19	13	21	08	06
PMDC03G	32	25	16	23	08	08



Cuscinetto EXTRA PICCOLO  
PMDC03XP



Cuscinetto PICCOLO  
PMDC03P



Cuscinetto MEDIO  
PMDC03M



Cuscinetto GRANDE  
PMDC03G



Imbottitura sottile e morbida



Rivestimento sfoderabile lycra/neoprene perforato



Areato



Ignifugo secondo la norma ISO 8191-1



Multiregolabile a regolazione orbitale



Attacco Estraibile  
PMDC06



Kit Hardware multiregolabile in alluminio con staffa orizzontale  
LUNGA PMDC05  
CORTA PMDC05C



Cod. ISO 18.09.39.027

Capitis anatomico compreso di hardware con staffa orizzontale lunga ed attacco estraibile

CODICE	MISURA
PMDC02XP	Extra Piccolo
PMDC02P	Piccolo
PMDC02M	Medio
PMDC02G	Grande

Cod. ISO 18.09.39.027

Capitis anatomico compreso di hardware con staffa orizzontale corta ed attacco estraibile

CODICE	MISURA
PMDC02XPC	Extra Piccolo
PMDC02PC	Piccolo
PMDC02MC	Medio
PMDC02GC	Grande

## Escursioni in profondità

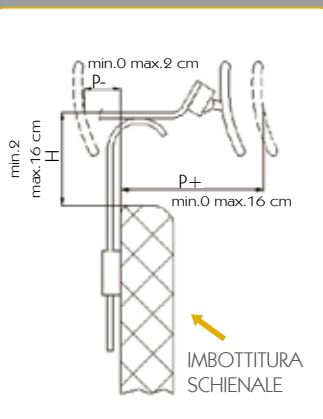

Staffa orizzontale inclinata verso l'alto

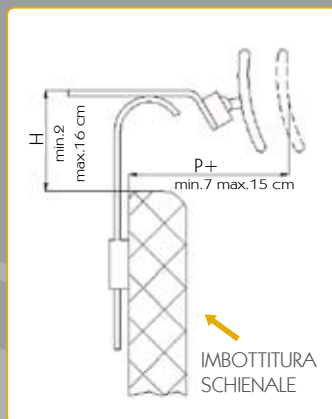

Staffa orizzontale inclinata verso il basso

## Accessori

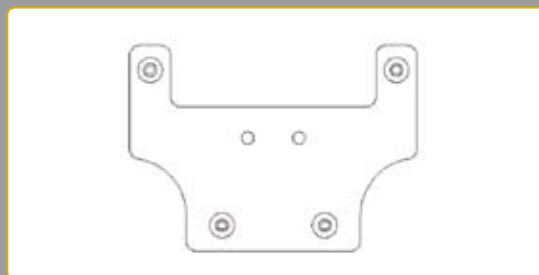

Piastra interfaccia per schienali PMDC17

Piastra di montaggio per schienali con scocca in plastica o in alluminio. È possibile effettuare l'installo del sistema capitis solo su schienali solidi.



PRODOTTO E DISTRIBUITO DA:



Via Montagna Z. I. L o t t o 4 1  
c.a.p. 72023 Mesagne (Br) - ITALY  
T e l . + 3 9 0 8 3 1 . 7 7 7 8 4 0  
F a x . + 3 9 0 8 3 1 . 7 3 0 7 3 9  
Sito web: [www.promedicare.it](http://www.promedicare.it)  
e mail: [info@promedicare.it](mailto:info@promedicare.it)